

DOC13035-C1

# Vision™ PLC+HMI

# Installation Guide

V130-33-TR6/V130-J-TR6  
 V350-35-TR6/V350-J-TR6  
 V430-J-RH6

- 8 Digital Inputs, including 2 Analog, 1 HSC/Shaft-encoder inputs
- 6 Relay Outputs
- 4 Analog Inputs (Current)
- 2 high-speed npn Transistor Outputs (TR6 Only)

## General Description

All of the controllers covered in this guide are micro-PLC+HMIs, rugged programmable logic controllers that comprise built-in operating panels and on-board I/Os.



Item	V130-TR6 V130J-TR6		V350-TR6 V350J-TR6		V430J-RH6
	On-board I/O	Model Dependent			
Screen	2.4"		3.5" Color Touch		4.3" Color Touch
Keypad	Yes		None		
Function Keys	None		Yes		
Com Port, Built-in					
RS232/485	Yes	Yes	Yes*	Yes*	Yes*
USB device, mini-B	None	None	Yes*	Yes*	Yes*
Com Ports, separate order, user-installed	The user may install a CANbus port (V100-17-CAN), and <b>one</b> of the following: <ul style="list-style-type: none"> <li>• RS232/RS485 port (V100-17-RS4/V100-17-RS4X)</li> <li>• Ethernet (V100-17-ET2)</li> <li>• Profibus Slave (V100-17-PB1)</li> </ul>				
* V430J/V350/V350J comprises both RS232/485 and USB ports; note that only <b>one</b> channel may be used at a time.					

## Standard Kit Contents



Item	V130-TR6 V130J-TR6		V350-TR6 V350J-TR6		V430J-RH6
	Controller	Yes			
Terminal Blocks	Yes				
Battery (installed)	Yes				
Slides (2 sets of key labels)	None		Yes		None
Mounting Brackets	Yes (2 parts)				Yes (4 parts)
Rubber Seal	Yes				

## Alert Symbols and General Restrictions

When any of the following symbols appear, read the associated information carefully.

Symbol	Meaning	Description
	Danger	The identified danger causes physical and property damage.
	Warning	The identified danger could cause physical and property damage.
<i>Caution</i>	Caution	Use caution.

- Before using this product, the user must read and understand this document.
- All examples and diagrams are intended to aid understanding, and do not guarantee operation. Unitronics accepts no responsibility for actual use of this product based on these examples.
- Please dispose of this product according to local and national standards and regulations.
- Only qualified service personnel should open this device or carry out repairs.

	▪ Failure to comply with appropriate safety guidelines can cause severe injury or property damage.
	▪ Do not attempt to use this device with parameters that exceed permissible levels. ▪ To avoid damaging the system, do not connect/disconnect the device when power is on.

## Environmental Considerations

- Do not install in areas with: excessive or conductive dust, corrosive or flammable gas, moisture or rain, excessive heat, regular impact shocks or excessive vibration, in accordance with the standards given in the product's technical specification sheet.
- Do not place in water or let water leak onto the unit.
- Do not allow debris to fall inside the unit during installation.
- Ventilation: 10mm space required between controller's top/bottom edges & enclosure walls.
- Install at maximum distance from high-voltage cables and power equipment.

## Mounting

Note that figures are for illustrative purposes only.

### Dimensions: V130/V350/V130J/V350J

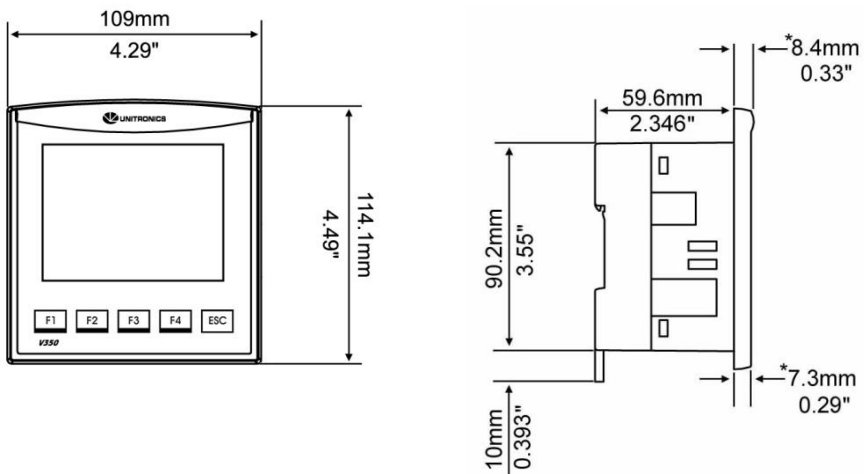

\* Note that for models V130J/V350J, the bezel width is 6.7 mm (0.26").

**Dimensions: V430J**

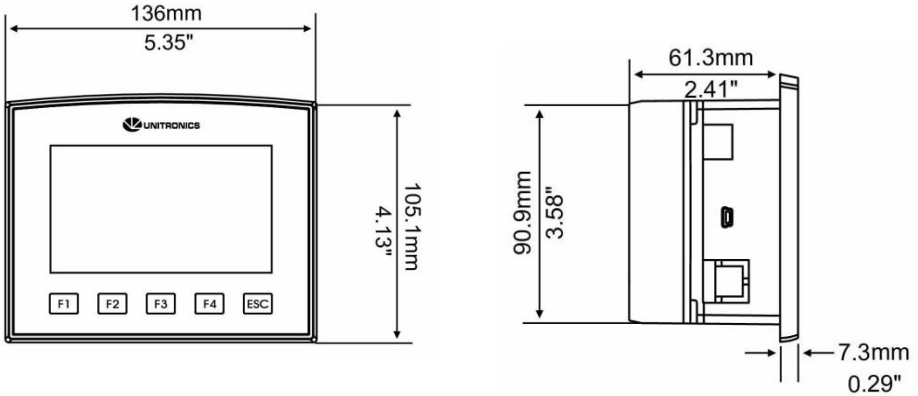

**Panel Mounting**

Before you begin, note that the mounting panel cannot be more than 5 mm thick.

**UL listed models:**

To meet the UL508 standard, panel-mount the device on the flat surface of a Type 1 enclosure.

1. Make a panel cut-out of the appropriate size:
  - V130/V350/V130J/V350J: 92x92 mm (3.622"x3.622").
  - V430J: 122.5x91.5 mm (4.82"x3.6").
2. Slide the controller into the cut-out, ensuring that the rubber seal is in place.
3. Push the mounting brackets into their slots on the sides of the panel as shown in the figure below.
4. Tighten the bracket's screws against the panel. Hold the bracket securely against the unit while tightening the screw.
5. When properly mounted, the controller is squarely situated in the panel cut-out as shown in the accompanying figures.

**V130/V350/V130J/V350J**

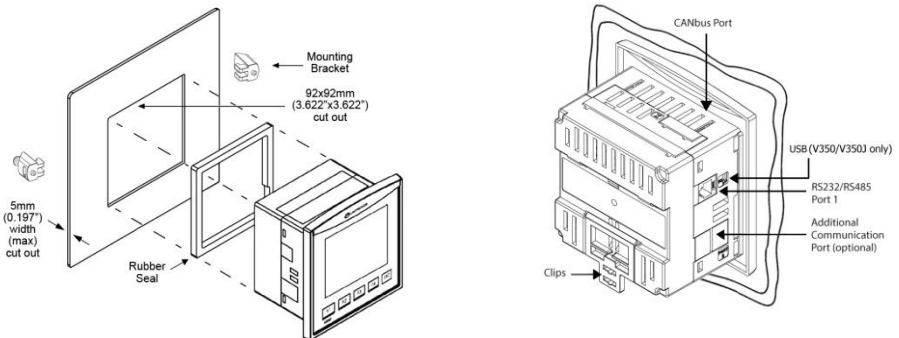

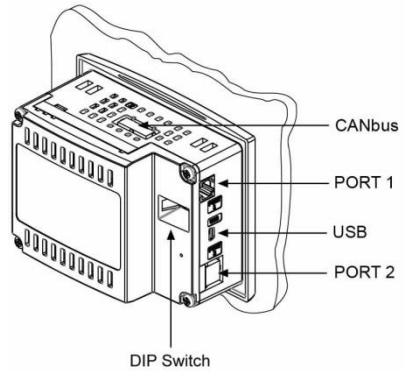
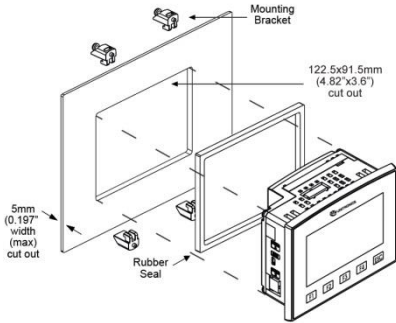
**V430J**

**Caution**   ▪ The necessary torque is 0.4 N·m (4 kgf·cm).

**DIN-rail Mounting (V130/V350/V130J/V350J)**

1. Snap the controller onto the DIN rail as shown in the figure to the right.

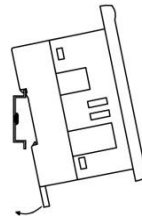

2. When properly mounted, the controller is squarely situated on the DIN-rail as shown in the figure to the right.

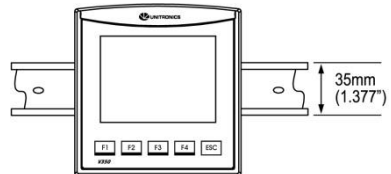

## Wiring



- Do not touch live wires.



- Install an external circuit breaker. Guard against short-circuiting in external wiring.
- Use appropriate circuit protection devices.
- Unused pins should not be connected. Ignoring this directive may damage the device.
- Double-check all wiring before turning on the power supply.

### Caution

- To avoid damaging the wire, do not exceed a maximum torque of 0.5 N·m (5 kgf·cm).
- Do not use tin, solder, or any substance on stripped wire that might cause the wire strand to break.
- Install at maximum distance from high-voltage cables and power equipment.

## Wiring Procedure

Use crimp terminals for wiring; use 3.31 mm<sup>2</sup>–0.13 mm<sup>2</sup> wire (12-16 AWG):

1. Strip the wire to a length of 7±0.5mm (0.270–0.300”).
  2. Unscrew the terminal to its widest position before inserting a wire.
  3. Insert the wire completely into the terminal to ensure a proper connection.
  4. Tighten enough to keep the wire from pulling free.
- Input or output cables should not be run through the same multi-core cable or share the same wire.
  - Allow for voltage drop and noise interference with I/O lines used over an extended distance. Use wire that is properly sized for the load.
  - The controller and I/O signals must be connected to the same 0V signal.

## I/Os

**V130/V350/V130J/V350J-TR6 models** comprise a total of 12 inputs, 6 relay and 2 npn outputs

**V430J-RH6** comprises a total of 12 inputs and 6 relay outputs.

Input functionality can be adapted as follows:

8 inputs may be used as digital inputs. They may be wired in a group and set to either npn or pnp via a single jumper.

4 inputs may be used as analog inputs, current (AN2-AN5).

In addition, according to jumper settings and appropriate wiring:

- Inputs 6 and 7 can function as either digital or analog inputs.
- Input 0 can function as high-speed counter, as part of a shaft-encoder, or as normal digital input.
- Input 1 can function as either counter reset, as part of a shaft-encoder, or as normal digital input.
- If input 0 high-speed counter (without reset), input 1 can function as normal digital input.

## Input Jumper Settings

The tables below show how to set a specific jumper to change input functionality. To access the I/O jumpers, you must open the controller according to the instructions beginning on page 11.

 Incompatible jumper settings and wiring connections may seriously damage the controller.

Digital Inputs 0-7: Set Type		
<b>Set to</b>	<b>JP1 (all Inputs)</b>	
npn (sink)	A	
pnp (source)*	B	
Inputs 6/7: Set as Digital or Analog		
<b>Set to</b>	<b>JP5 (Input 6)</b>	<b>JP6 (Input 7)</b>
Digital*	A	A
Analog	B	B
Analog Inputs AN0/AN1: Set Type		
<b>Set to</b>	<b>JP3 (AN0)</b>	<b>JP4 (AN1)</b>
Voltage*	A	A
Current	B	B

\*Default settings

TR6

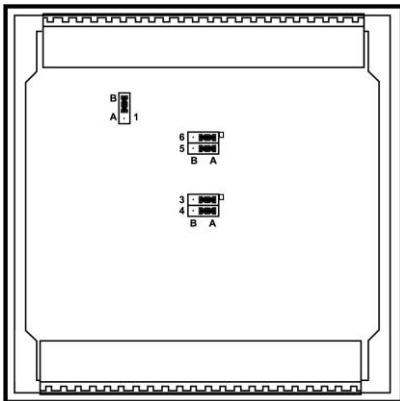

RH6

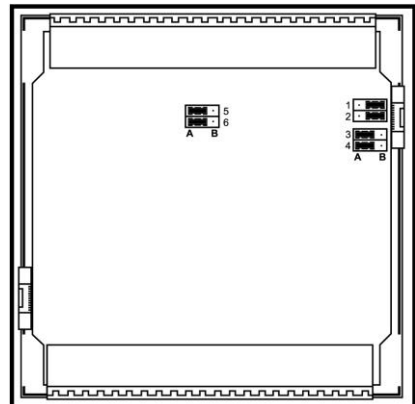

**I/O Wiring**

**npn (sink) Input**

Input wiring

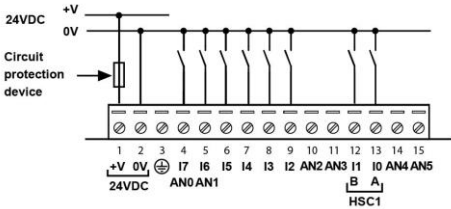

HSC input wiring

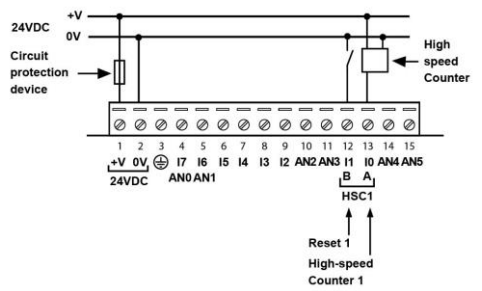

**pnp (source) Input**

Input wiring

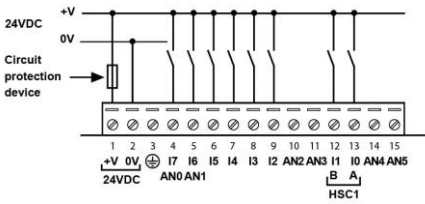

HSC input wiring

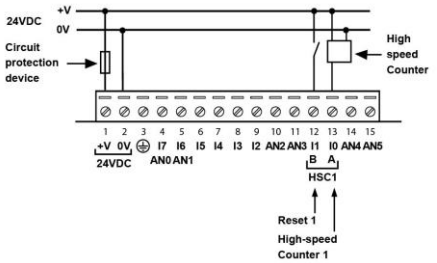

**Shaft-encoder**

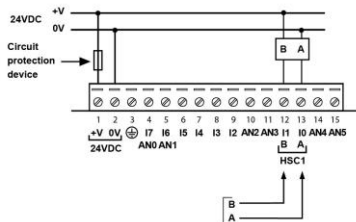

### Analog Input

Current connections (2/3-wire)

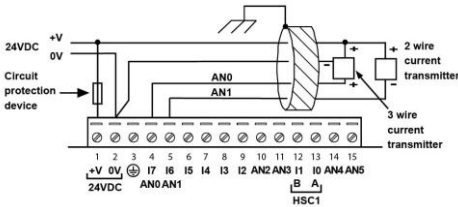

Analog input wiring, current (4-wire), voltage

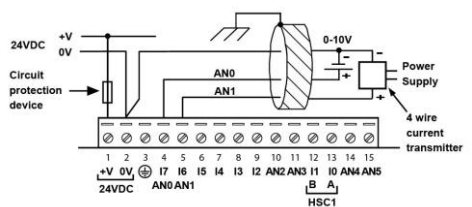

Shields should be connected at the signal's source.

The 0V signal of the analog input must be connected to the controller's 0V.

Please notice that AN2 to AN5 may be used as analog current inputs only.

### Relay Outputs

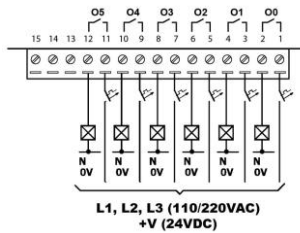

### Increasing Contact Life Span

To increase the life span of the relay output contacts and protect the device from potential damage by reverse EMF, connect:

- A clamping diode in parallel with each inductive DC load
- An RC snubber circuit in parallel with each inductive AC load

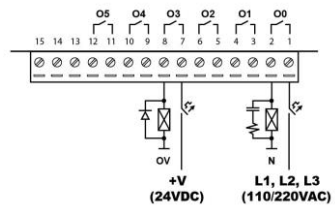



**npn Outputs (TR6 Only)**

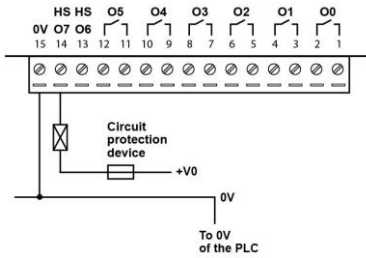

**Power Supply**

The controller requires an external 24VDC power supply.



- The power supply must include double insulation. Outputs must be rated as SELV/PELV/Class2/Limited Power.

- Use separate wires to connect the functional earth line (pin 3) and the 0V line (pin 2) to the system earth ground.

- Install an external circuit breaker. Guard against short-circuiting in external wiring.



- Double-check all wiring before turning on the power supply.
- Do not connect either the 'Neutral' or 'Line' signal of the 110/220VAC to device's 0V pin
- In the event of voltage fluctuations or non-conformity to voltage power supply specifications, connect the device to a regulated power supply.

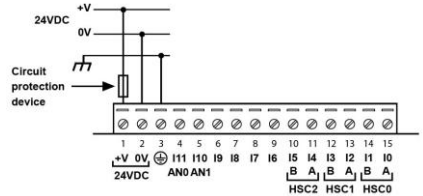

**Earthing the PLC+HMI**

To maximize system performance, avoid electromagnetic interference by:

- Mounting the controller on a metal panel.
- Connect each common and ground connection directly to the earth ground of your system.
- For ground wiring uses the shortest and thickest possible wire.

**Communication**

- **V130/V130J**  
These models comprise a built-in RS232/RS485 serial port (Port 1)
- **V430J/V350/V350J**  
These models comprise built-in ports: 1 USB and 1 RS232/RS485 (Port 1).

Note that physically connecting a PC to the controller via USB suspends RS232/RS485 communications via Port 1. When the PC is disconnected, RS232/RS485 resumes.

**RS232/RS485 Port**



- Turn off power before making communications connections.

**Caution** ▪ Always use the appropriate port adapters.

- Signals are related to the controller's 0V; the same 0V is used by the power supply.

**Caution** ▪ The serial port is not isolated. If the controller is used with a non-isolated external device, avoid potential voltage that exceeds  $\pm 10V$ .

- Use RS232 to download programs from a PC, and to communicate with serial devices and applications, such as SCADA.
- Use RS485 to create a multi-drop network containing up to 32 devices.

**Pinouts**

The pinouts below show the PLC port signals.

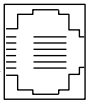
RS232		RS485**		Controller Port
Pin #	Description	Pin #	Description	
1*	DTR signal	1	A signal (+)	
2	0V reference	2	(RS232 signal)	
3	TXD signal	3	(RS232 signal)	
4	RXD signal	4	(RS232 signal)	
5	0V reference	5	(RS232 signal)	
6*	DSR signal	6	B signal (-)	

\* Standard programming cables do not provide connection points for pins 1 and 6.

\*\* When a port is adapted to RS485, Pin 1 (DTR) is used for signal A, and Pin 6 (DSR) signal is used for signal B.

Note that it is possible to establish a PC to PLC connection using RS232 even when the PLC is set to RS485 (this eliminates the need to open the controller to set jumpers).

To do so, remove the RS485 connector (pins 1 & 6) from the PLC and connect a standard RS232 programming cable.

Note that this is possible only if DTR and DSR signals of RS232 are not used (which is the standard case).

**Setting RS232/RS485 Communication Parameters, V130/V350/V130J/V350J**

This port may be set to either RS232 or RS485 via jumper.

The accompanying figure shows the jumper factory default settings.

These jumpers may be used to:

- Set communications to RS485, by setting both COMM jumpers to '485'.
- Set RS485 termination, by setting both TERM jumpers to 'OFF'.

To access the jumpers, you must open the controller according to the instructions on page 11.

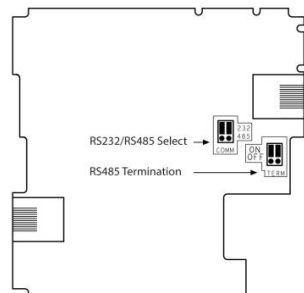

**Setting RS232/RS485 Communication Parameters, V430J**

This port may be set to either RS232 or RS485 via DIP switches:

The table shows the DIP switches factory default settings. Use the table to adapt the settings.

Switch Settings
-----------------

	1	2	3	4	5	6
RS232*	ON	OFF	OFF	ON	OFF	OFF
RS485	OFF	ON	ON	OFF	OFF	OFF
RS485 with termination**	OFF	ON	ON	OFF	ON	ON

\* Default factory setting

\*\* Causes the unit to function as an end unit in an RS485 network

## USB Port

*Caution*   ▪ The USB port is not isolated.  
Make sure that the PC and the controller are grounded to same potential.

The USB port may be used for programming, OS download, and PC access.

## Opening the Controller



- Before performing these actions, touch a grounded object to discharge any electrostatic charge.
- Avoid touching the PCB board directly. Hold the PCB board by its connectors.

1. Turn off the power supply, disconnect, and dismount the controller.
2. The back cover of the controller comprises 4 screws, located in the corners.  
Remove the screws, and pull off the back cover.

## Changing I/O Settings

After opening the controller and exposing the I/O board, you can change the jumper settings according to the table shown above.

## Changing Communication Settings (V130/V350/V130J/V350J Only)

1. To access the communication jumpers, hold the I/O PCB board by its top and bottom connectors and steadily pull the board off.
2. Locate the jumpers, and then change the settings as required, according to the jumpers' settings shown on page 10.

## Closing the Controller

1. Gently replace the board. Make certain that the pins fit correctly into their matching receptacle.  
Do not force the board into place; doing so may damage the controller.
2. Replace the back cover of the controller and fasten the corner screws.

**Note that you must replace the back cover securely before powering up the controller.**

The information in this document reflects products at the date of printing. Unitronics reserves the right, subject to all applicable laws, at any time, at its sole discretion, and without notice, to discontinue or change the features, designs, materials and other specifications of its products, and to either permanently or temporarily withdraw any of the forgoing from the market.

All information in this document is provided "as is" without warranty of any kind, either expressed or implied, including but not limited to any implied warranties of merchantability, fitness for a particular purpose, or non-infringement. Unitronics assumes no responsibility for errors or omissions in the information presented in this document. In no event shall Unitronics be liable for any special, incidental, indirect or consequential damages of any kind, or any damages whatsoever arising out of or in connection with the use or performance of this information.

The tradenames, trademarks, logos and service marks presented in this document, including their design, are the property of Unitronics (1989) (R'G) Ltd. or other third parties and you are not permitted to use them without the prior written consent of Unitronics or such third party as may own them

DOC13035-C1 05/18