

JZ10-11-UA24

Jazz™ Micro-OPLC™ Installation Guide

9 Digital, 2 Analog/Digital, 2 Analog Inputs, 2 PT100/TC,
5 Relay, 2 PNP, 2 Analog Outputs

- Before using this product, the user must read and understand this document.
- For additional information regarding this product, refer to the user guide and technical specifications.
- All examples and diagrams are intended to aid understanding, and do not guarantee operation. Unitronics accepts no responsibility for actual use of this product based on these examples.
- Please dispose of this product according to local and national standards and regulations.
- Only qualified service personnel should open this device or carry out repairs.



Failure to comply with appropriate safety guidelines can cause severe injury or property damage.



- Do not attempt to use this device with parameters that exceed permissible levels.
- To avoid damaging the system, do not connect/disconnect the device when power is on.

Environmental Considerations



- Do not install in areas with: excessive or conductive dust, corrosive or flammable gas, moisture or rain, excessive heat, regular impact shocks or excessive vibration.



- Ventilation: 10mm space required between the controller's top/bottom edges & enclosure walls.
- Do not place in water or let water leak onto the unit.
- Do not allow debris to fall inside the unit during installation.

Mounting

Dimensions

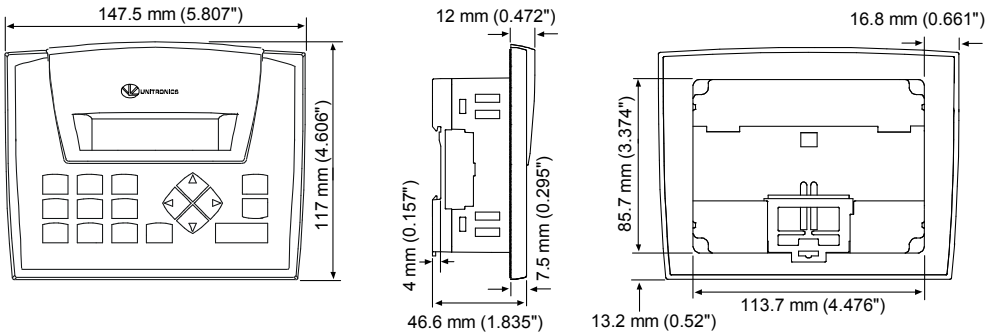

Add-on modules

Note: Installing an add-on module requires space.

During installation

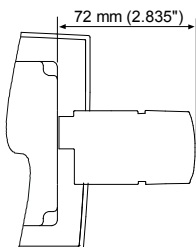

After installation

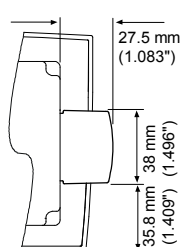

Panel mounting

- Cut-out: 117 x 89mm (WxH) 4.606" x 3.504"
- Hold bracket against unit while tightening screw

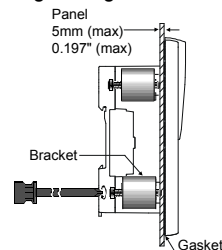

DIN-rail mounting

Mounting

Snap PLC onto the DIN rail

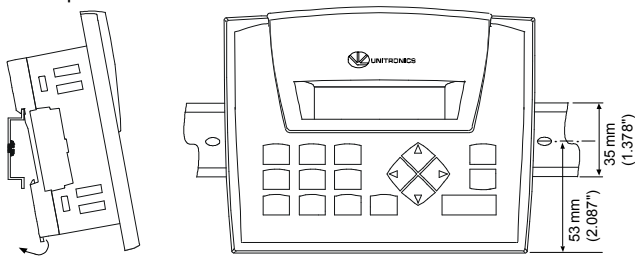

Removal

Push mounting clip down

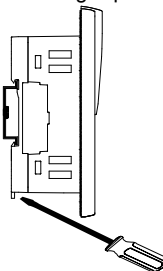

Note: Removing the unit requires clearance space. Recommendation: approximately 40mm (1.58”).

Wiring

Note: All diagrams are based on the rear view of the OPLC.



- Do not touch live wires.

- Install an external circuit breaker. Guard against short-circuiting in external wiring.



- Use appropriate circuit protection devices.
- Unused pins should not be connected. Ignoring this directive may damage the device.
- Double-check all wiring before turning on the power supply.

- To avoid damaging the wire, do not exceed a maximum torque of 0.5 N·m (5 kgf·cm).
- Do not use tin, solder, or any substance on stripped wire that might cause the wire strand to break.
- Install at maximum distance from high-voltage cables and power equipment.

Use crimp terminals for wiring; use 26-12 AWG wire (0.13 mm²–3.31 mm²).

1. Strip the wire to a length of 7±0.5mm (0.250–0.300 inches).
2. Unscrew the terminal to its widest position before inserting a wire.
3. Insert the wire completely into the terminal to ensure a proper connection.
4. Tighten enough to keep the wire from pulling free.

- Input or output cables should not be run through the same multi-core cable or share the same wire.
- Allow for voltage drop and noise interference with input lines used over an extended distance. Use wire that is properly sized for the load.
- The controller, I/O signals, and outputs' power supply must be connected to the same 0V signal.

Inputs

This model comprises a total of 15 inputs in 4 groups.

1. I0 to I8 are digital inputs. They may be wired, in a group, as either npn or pnp.
2. I9 and I10 may be wired as either digital or analog inputs. These may be wired as either:
 - npn digital inputs
 - pnp digital inputs
 - analog (voltage) inputs

In addition, 1 input may be wired as a pnp input, while the other is wired as an analog input. Note that if 1 input is wired as an npn input, the other may not be wired as an analog input.

3. AN2 and AN3 are analog (current) inputs that may be wired using 2, 3, or 4 wires.
4. Analog Input 0 and 1 can function as either thermocouple or PT100 inputs; each PT100 signal has its own CM signal.

Digital Inputs, Controller's Power Supply

Note: The inputs are arranged in two groups. You can wire one group as npn and the other as pnp, or wire both groups as npn, or as pnp. In either case, the npn/pnp pins must be connected.

Input wiring, npn (sink)

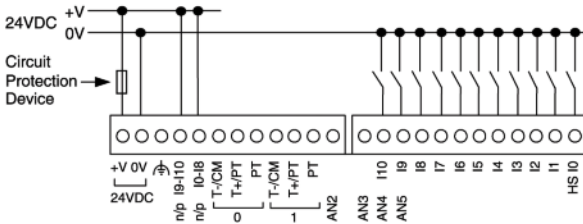

Input wiring, pnp (source)

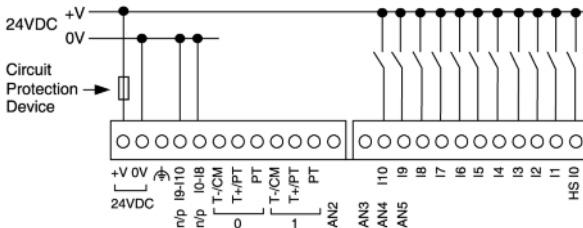

Input wiring, (I0-I8), pnp (source), (I9-I10), npn (sink)

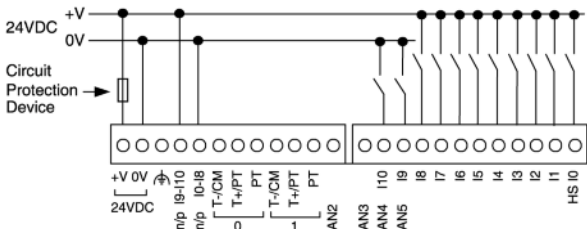

Analog Inputs

Note: Shields should be connected at the signal source.

Analog Input wiring, current, 2 or 3 wire, AN2 and AN3

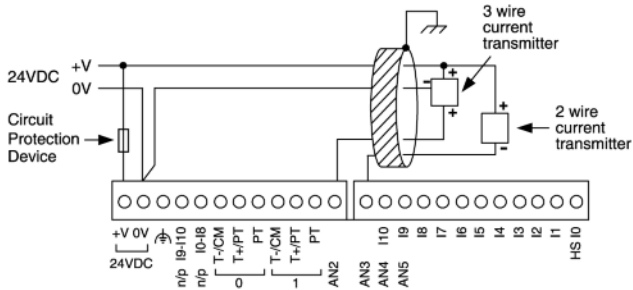

Analog Input wiring, current, 4 wire, AN2 and AN3

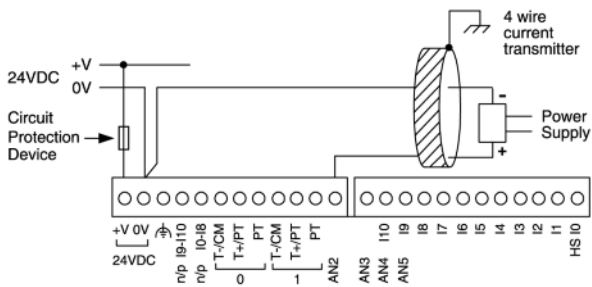

Analog Input wiring, voltage, AN4 and AN5

Note: If either I9 or I10 is wired as an npn digital input, the remaining input may not be wired as an analog input.

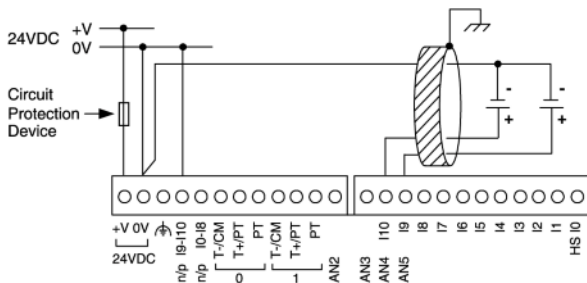

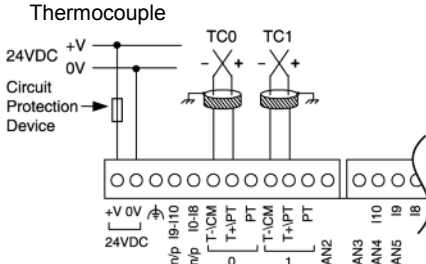

- Thermocouple 0: use T- Input as negative input and T+ as positive.
- Thermocouple 1: use T- Input as negative input and T+ as positive.

Type	Temp. Range	Wire Color	
		ANSI (USA)	BS1843 (UK)
mV	-5 to 56mV		
B	200 to 1820°C (300 to 3276°F)	+Grey -Red	+None -Blue
E	-200 to 750°C (-328 to 1382°F)	+Violet -Red	+Brown -Blue
J	-200 to 760°C (-328 to 1400°F)	+White -Red	+Yellow -Blue
K	-200 to 1250°C (-328 to 2282°F)	+Yellow -Red	+Brown -Blue
N	-200 to 1300°C (-328 to 3214°F)	+Orange -Red	+Orange -Blue
R	0 to 1768°C (32 to 3214°F)	+Black -Red	+White -Blue
S	0 to 1768°C (32 to 3214°F)	+Black -Red	+White -Blue
T	-200 to 400°C (-328 to 752°F)	+Blue -Red	+White -Blue

RTD

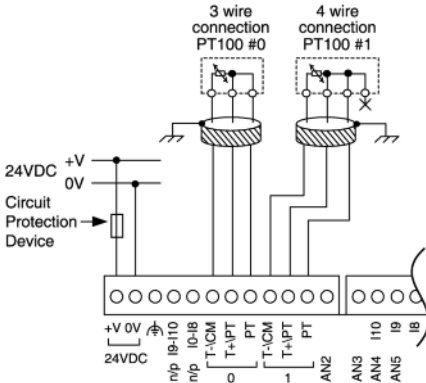

- PT100 (Sensor 0): use both inputs related to CM signal
- PT100 (Sensor 1): use both inputs related to CM signal
- 4 wire PT100 can be used by leaving one of the sensor leads unconnected.

Digital Outputs, Outputs' Power Supply

PNP Outputs

+VO is the power supply input for pnp outputs O5–O6.

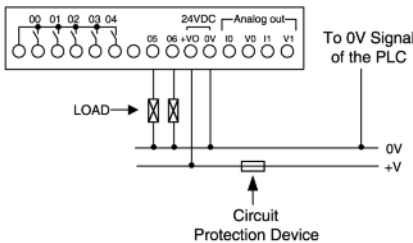

Relay Outputs

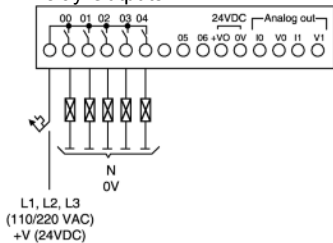

Increasing contact life span

To increase the life span of your contacts & protect the unit from potential damage by reverse-EMF, connect:

- A clamping diode in parallel with each inductive DC load
- An RC snubber circuit in parallel with each inductive AC load

AC

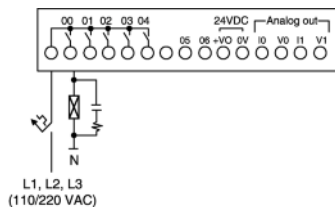

DC

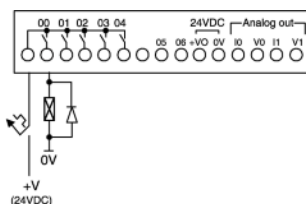

Analog Outputs

Current/voltage connections

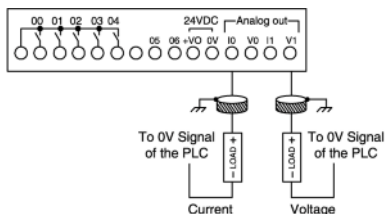

The information in this document reflects products at the date of printing. Unitronics reserves the right, subject to all applicable laws, at any time, at its sole discretion, and without notice, to discontinue or change the features, designs, materials and other specifications of its products, and to either permanently or temporarily withdraw any of the foregoing from the market.

All information in this document is provided "as is" without warranty of any kind, either expressed or implied, including but not limited to any implied warranties of merchantability, fitness for a particular purpose, or non-infringement. Unitronics assumes no responsibility for errors or omissions in the information presented in this document. In no event shall Unitronics be liable for any special, incidental, indirect or consequential damages of any kind, or any damages whatsoever arising out of or in connection with the use or performance of this information.

The tradenames, trademarks, logos and service marks presented in this document, including their design, are the property of Unitronics (1989) (R[®]G) Ltd. or other third parties and you are not permitted to use them without the prior written consent of Unitronics or such third party as may own them.